

PlayMounds

Medium PlayMound – 8'

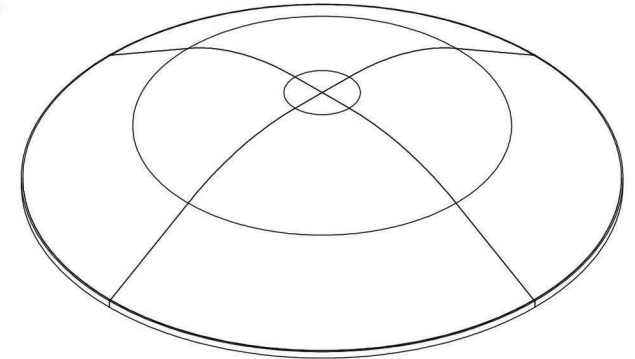
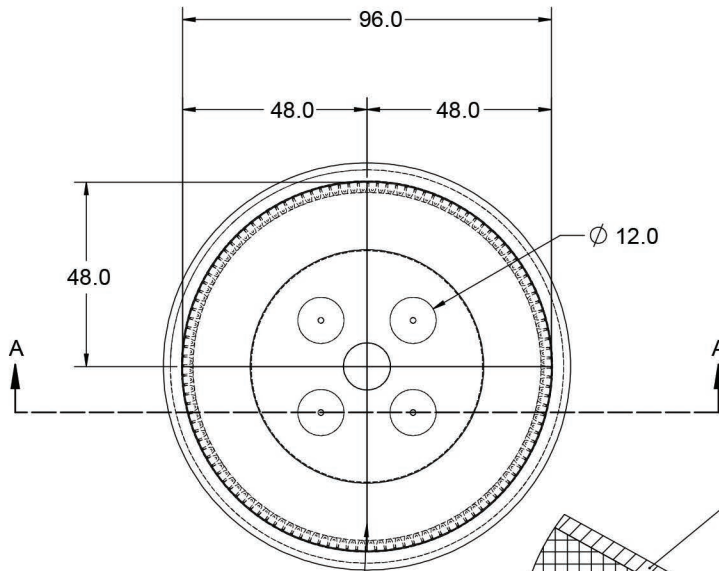

PlayMounds™ patent pending Layering System by ForeverLawn®
 EPP PROTECTIVE FOAM LAYER
 EPS GEO FOAM CORE
 HDPE NAILER FOR SECURING FOREVERLAWN TURF

PLAYMOUND SECTIONS MUST BE GLUED TOGETHER USING GREAT STUFF PRO™

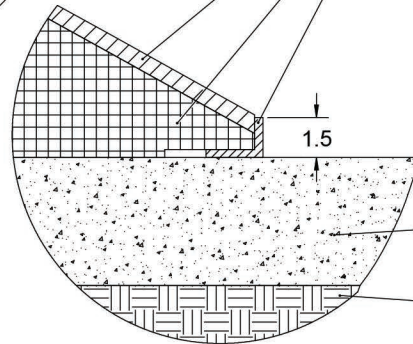

DETAIL A
SCALE 1:3

GROUND ANCHORING SYSTEM

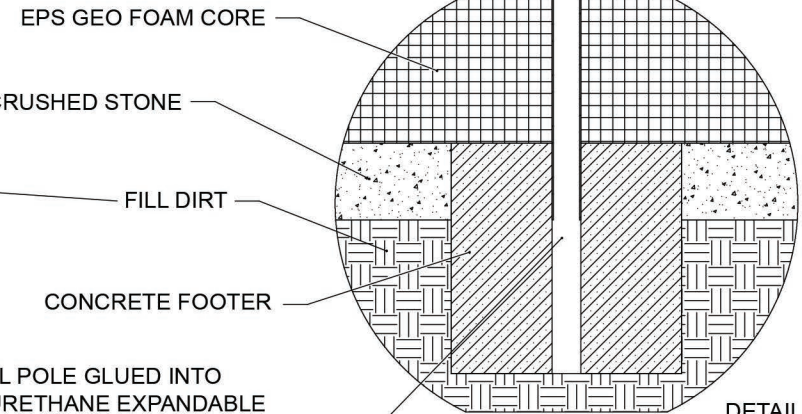

DETAIL B
SCALE 1:5

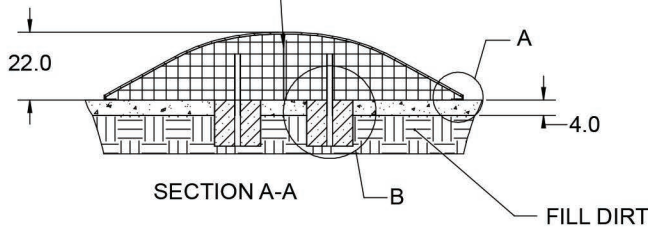

GALVANIZED STEEL POLE GLUED INTO GEO FOAM WITH URETHANE EXPANDABLE FOAM THEN SUNK INTO THE CONCRETE FOOTER

Units: Feet and inches

Material	Polystyrene	
Covering	Turf (sold separately)	
Weight	54 lb (100 lb turfed)	
Drawing No.	M1537	12/24